

<b>DE</b>	<b>Montageanleitung</b> Technische Änderungen vorbehalten.
<b>FR</b>	<b>Notice de montage</b> Sous réserve de modifications techniques.
<b>GB</b>	<b>Installation instructions</b> We reserve the right to introduce technical changes without notice.
<b>NL</b>	<b>Montagehandleiding</b> Technische wijzigingen voorbehouden.
<b>IT</b>	<b>Istruzioni per il montaggio</b> Ci si riserva il diritto di modifiche tecniche.
<b>ES</b>	<b>Instrucciones para el montaje</b> Modificaciones técnicas reservadas
<b>PL</b>	<b>Instrukcja montażu</b> Zastrzega się możliwość zmian technicznych.

<b>CZ</b>	<b>Montážní návod</b> Technické změny vyhrazeny.
<b>SK</b>	<b>Návod na montáž</b> Technické zmeny vyhradené.
<b>RU</b>	<b>Монтажная инструкция</b> Технические изменения не исключаются
<b>CN</b>	<b>安装说明</b> 技术上可能变化
<b>SE</b>	<b>Monteringsanvisning</b> Tekniska ändringar förbehålls.
<b>DK</b>	<b>Monteringsvejledning</b> Forbehold for tekniske ændringer.
<b>HU</b>	<b>Szerelési útmutató</b> Műszaki változtatások jogát fenntartjuk.

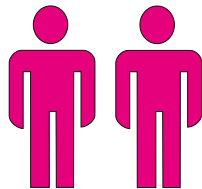

**Empfohlene Montage mit 2 Personen!**  
**Deux personnes sont recommandées pour le montage!**  
**Installation by 2 persons recommended!**  
**Montage met 2 personen aanbevolen!**  
**Montaggio consigliato con 2 persone!**  
**¡Montaje recomendado con 2 personas!**  
**Zaleca się montaż w dwie osoby!**  
**Pro montáž jsou doporučeny 2 osoby!**  
**Odporučame montáž s 2 osobami!**  
**Предусмотренный монтаж 2человека!**  
**建设由两人安装**  
**Vi rekommenderar att vara 2 personer under monteringen!**  
**Anbefalet montering af 2 personer!**  
**2 ember javasolt az összeszereléshez!**

**Persönliche Schutzkleidung empfohlen!**  
**Personal protective equipment recommended !**  
**Port de lunettes et de gants de protection obligatoire!**  
**Persoonlijke beschermkleding aanbevolen!**  
**Si raccomanda l'utilizzo di indumenti protettivi personali!**  
**Se recomienda llevar ropa de protección personal!**  
**Zaleca się osobiste ubranie ochronne!**  
**Doporučujeme ochranný oděv!**  
**Odporúča sa nosiť osobný ochranný odev!**  
**Рекомендуется индивидуальная защитная одежда!**  
**建设穿着个人防护服!**  
**Vi rekommenderar att bära personlig skyddsutrustning.**  
**Brug af personlige værnemidler anbefales.**  
**Egyéni védőfelszerelés javasolt**

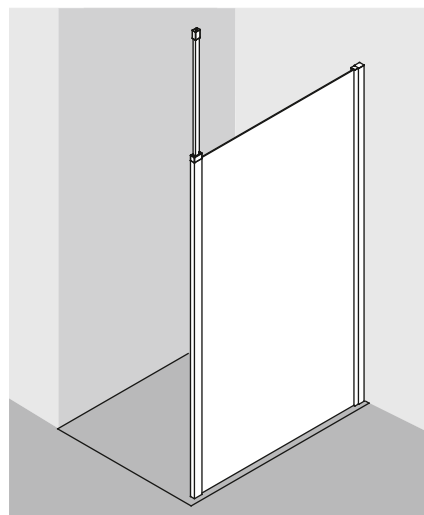
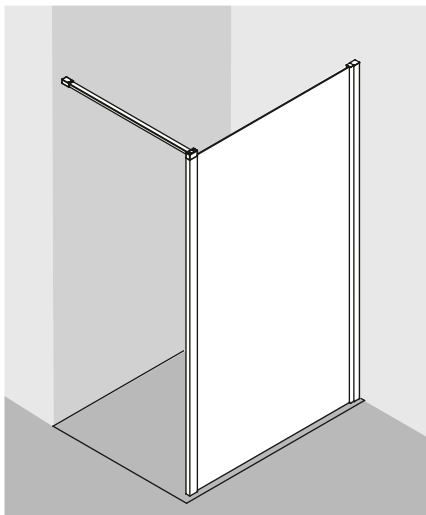





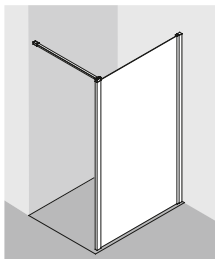



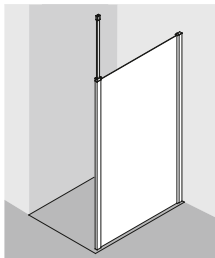



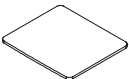

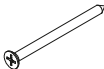
Zubehör / Accessoires / Fittings / Toebehoren / Accessori / Accesorios / Osprzęt / Příslušenství  
 Príslušenstvo / Принадлжности / 附件 / Tillbehör / Tilbehør / felszerelés

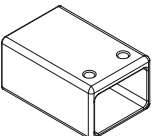

WDW

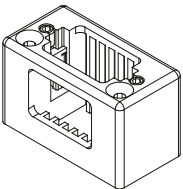

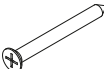
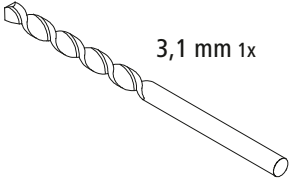
WDW

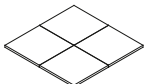
	4624 1x		4666 B4,2x7,5-TX15 3x
	4625 1x		N15 B3,5x50-TX15 2x
	3211 3x		N198 M5x5 2x
	97112 1x		N60 6mm 3x
	95144BG 1x		N189 4x50-TX20 3x
	95141BG 1x		N104 8mm 1x
			N116 5x60-TX25 1x
			3,1 mm 1x
			8417 1mm 4x
			8417 2mm 4x
			8417 3mm 2x
			1x

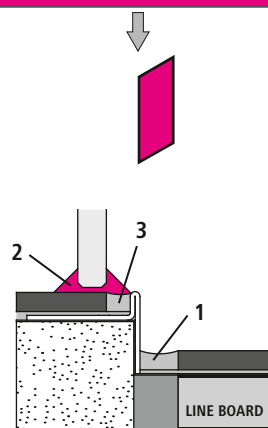
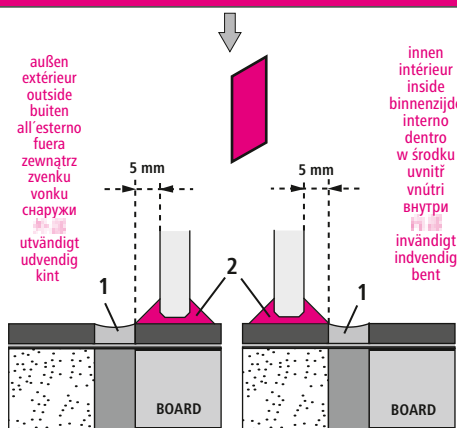

**1 Wartungsfuge / Joint de maintenance / Maintenance joint / Voegnaad / Fughe di manutenzione**  
 Junta de mantenimiento / Spoina wymagająca konserwacji / Spára pro údržbu / Servisná medzera  
 Технологический шов / Uderhållstog / Vedligeholdelsesfuge / szilikon fuga

**2 Versiegelung / Scellement / Sealing / Siliconen-kitnaad / Sigillatura**  
 Sellado / Uszczelnienie zewnętrzne / Uzavírací nátěr / Tesniaci hmota  
 Герметик / Försegling / Forsegling / Elzárás

**3 Zementfuge / Joint en ciment / Cement joint / Cementvoeg / Fuga di cemento**  
 Junta de cemento / Spoina cementowa / Cementová spára / Cementová medzera  
 Цементный шов / Cementfog / Cementfuge / Cement fuga

	WE	M	BV	GAK
Typ 70	685 - 710	675 - 700	675 - 700	665 - 690
Typ 75	735 - 760	725 - 750	725 - 750	715 - 740
Typ 80	785 - 810	775 - 800	775 - 800	765 - 790
Typ 90	885 - 910	875 - 900	875 - 900	865 - 890
Typ 100	985 - 1010	975 - 1000	975 - 1000	965 - 990
Typ 110	1085 - 1110	1075 - 1100	1075 - 1100	1065 - 1090
Typ 120	1185 - 1210	1175 - 1200	1175 - 1200	1165 - 1190
Typ 140	1385 - 1410	1375 - 1400	1375 - 1400	1365 - 1390

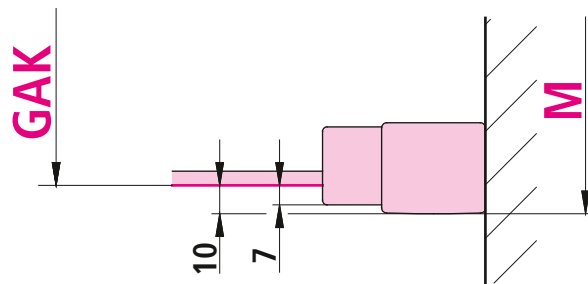
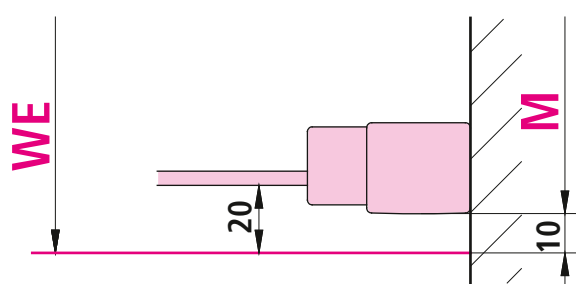
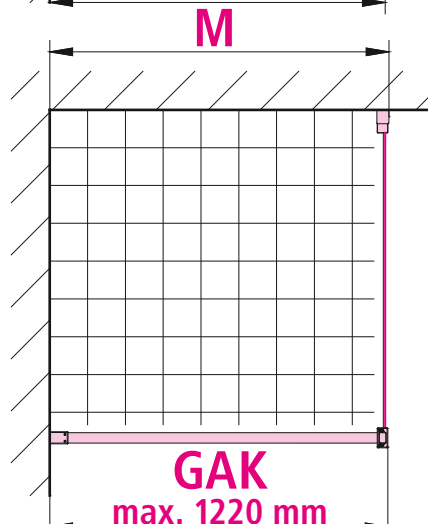
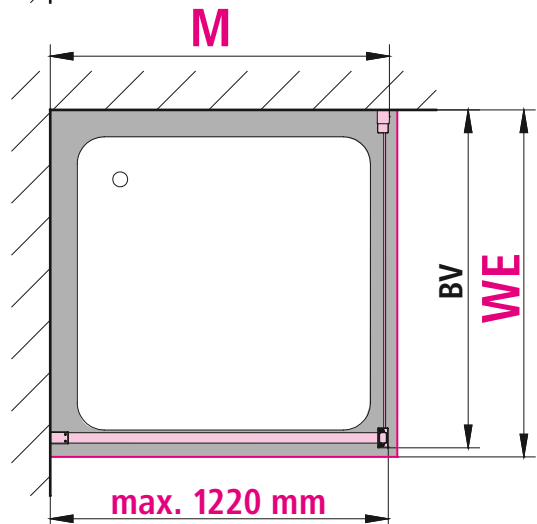
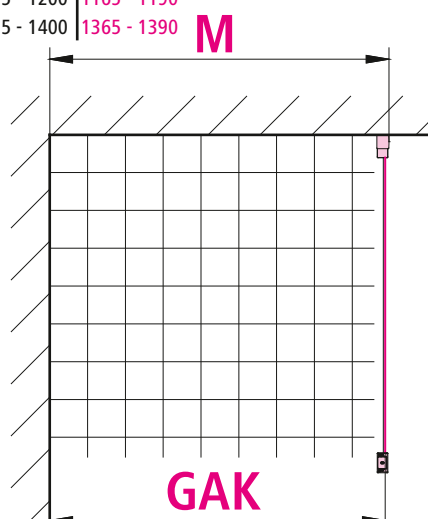
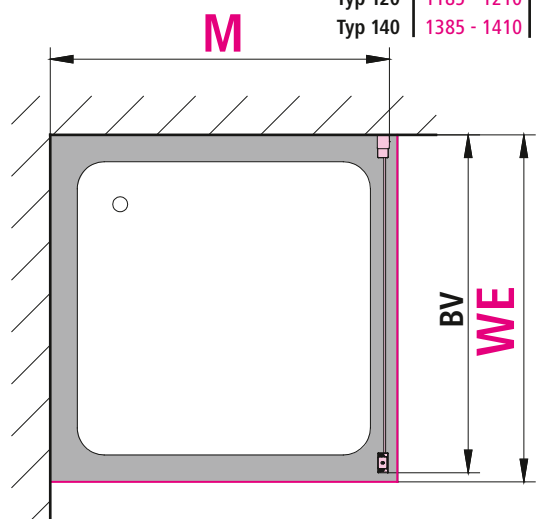

Achtung! / Attention! / Let ori / Attenzione! / Atención! / Uwaga! / Pozor!  
 Pozor! / Внимание! / 注意! / Observera! / Giv agti / Figyelem!

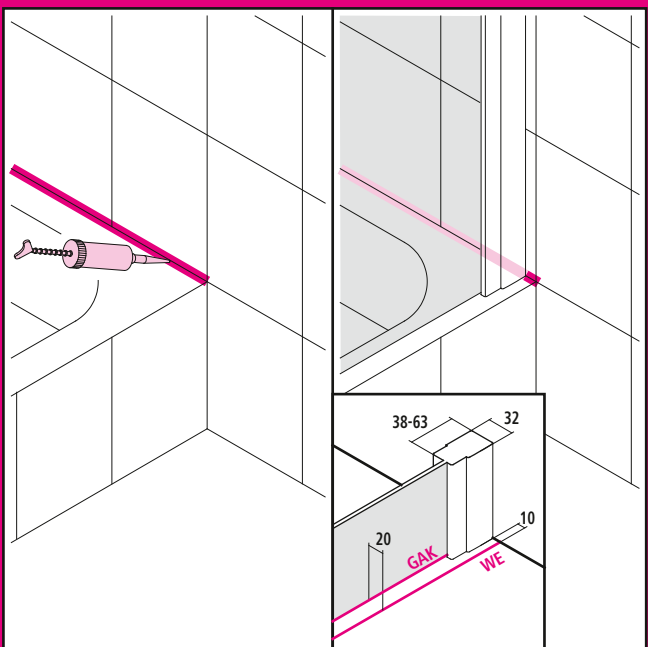
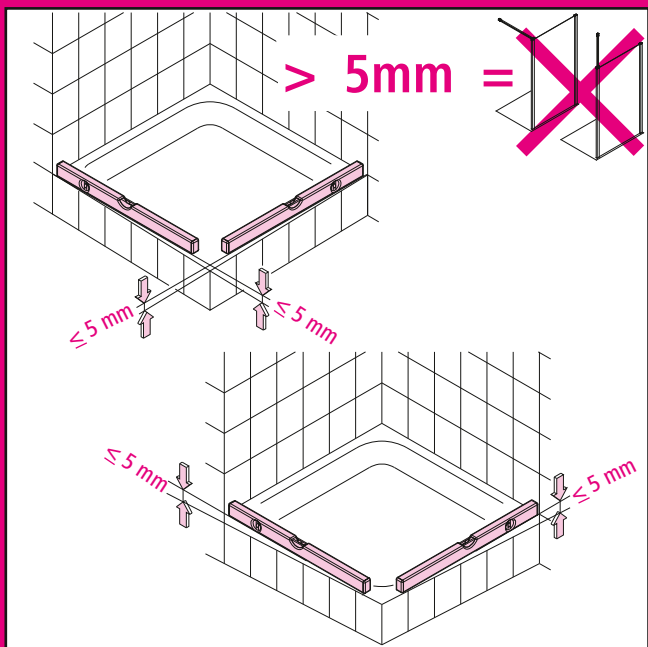

Achtung! / Attention! / Let ori / Attenzione! / Atención! / Uwaga! / Pozor!  
 Pozor! / Внимание! / 注意! / Observera! / Giv agti / Figyelem!

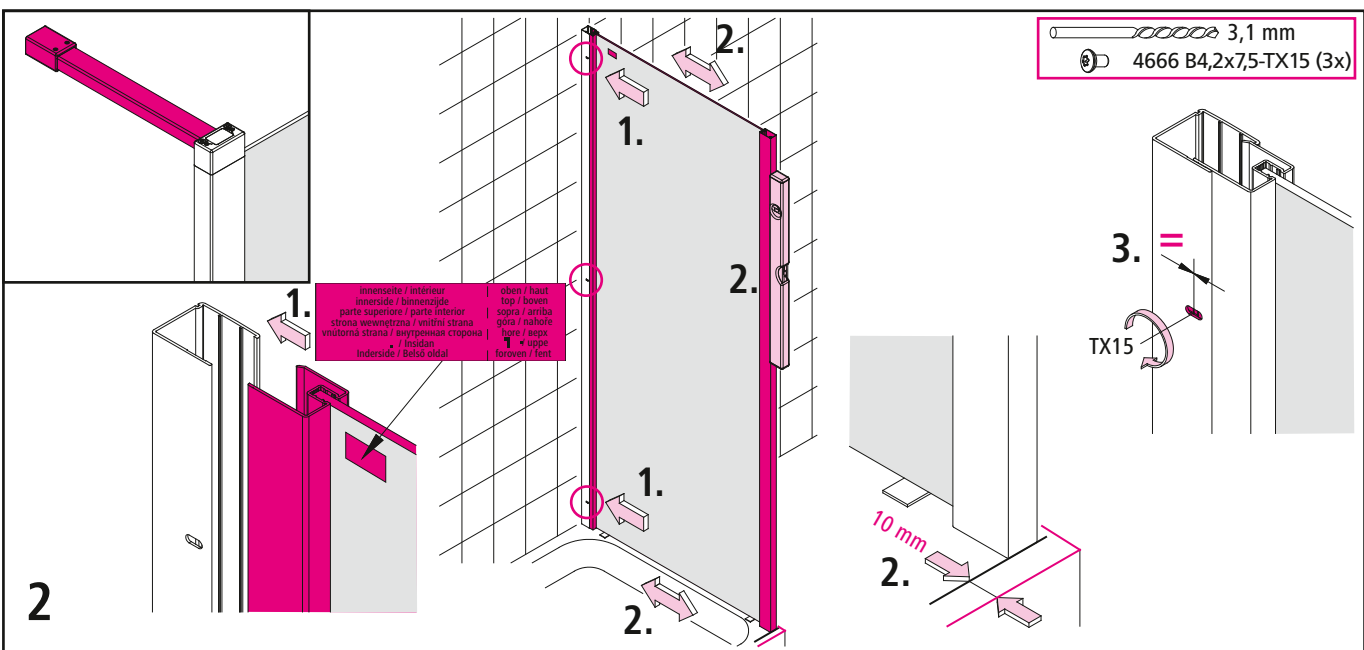
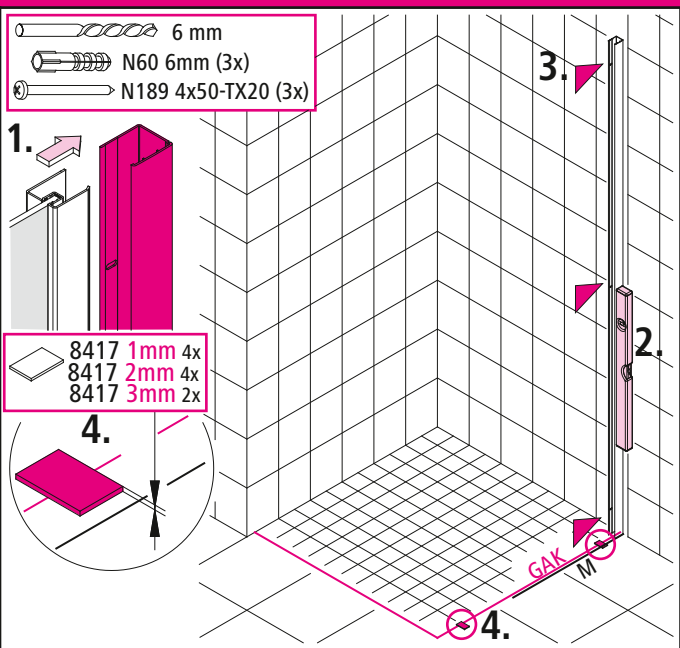
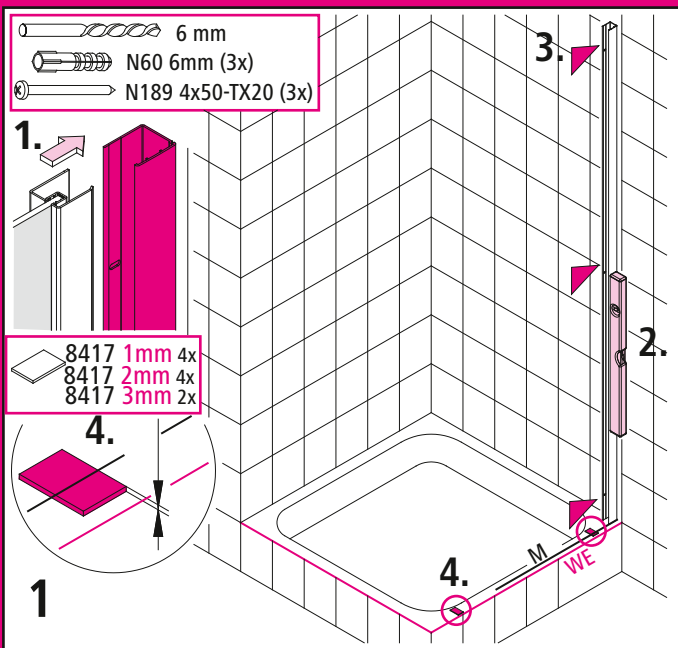

innenside / intérieur  
 innerside / binenside  
 parte superiore / parte interior  
 strana wewnetrzna / wnitri strana  
 vidnorna strana / avyrypnas cropona  
 / / inside  
 innerside / Belső oldal

oben / haut  
 (top / boven)  
 sopra / arriba  
 góra / nahore  
 fene / sepi  
 ↑  
 uppe  
 foroven / fent

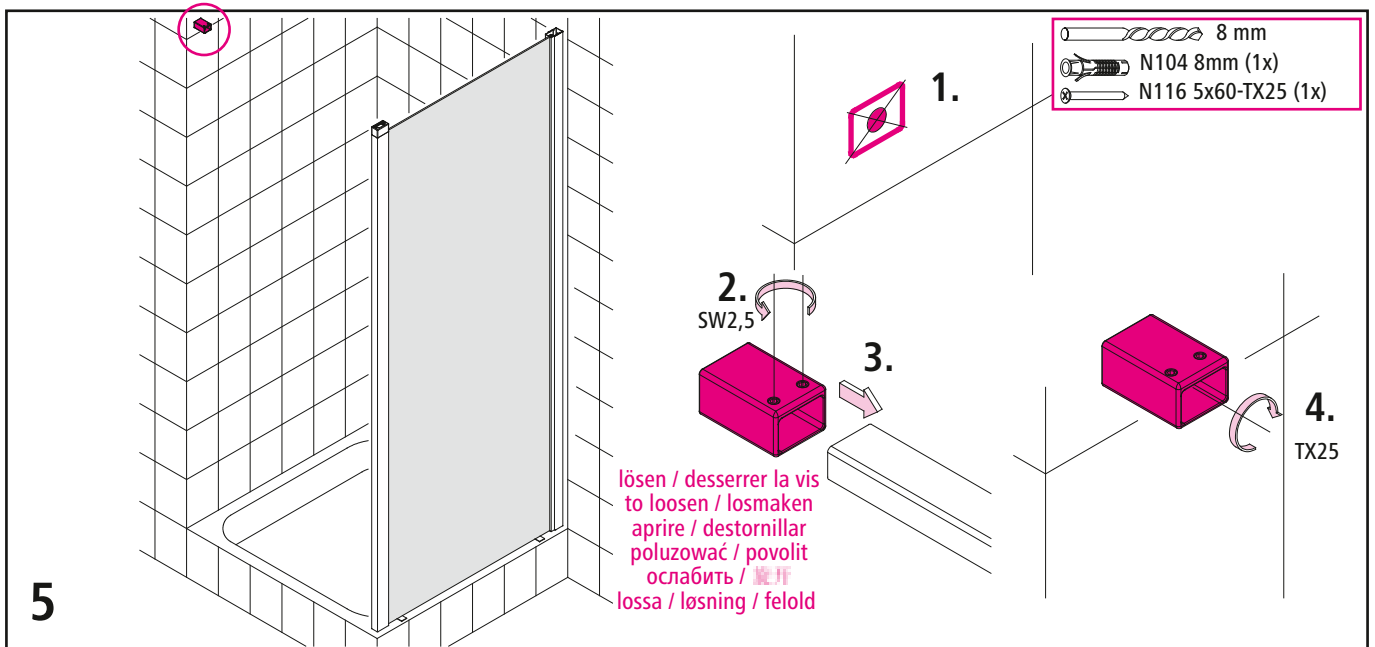
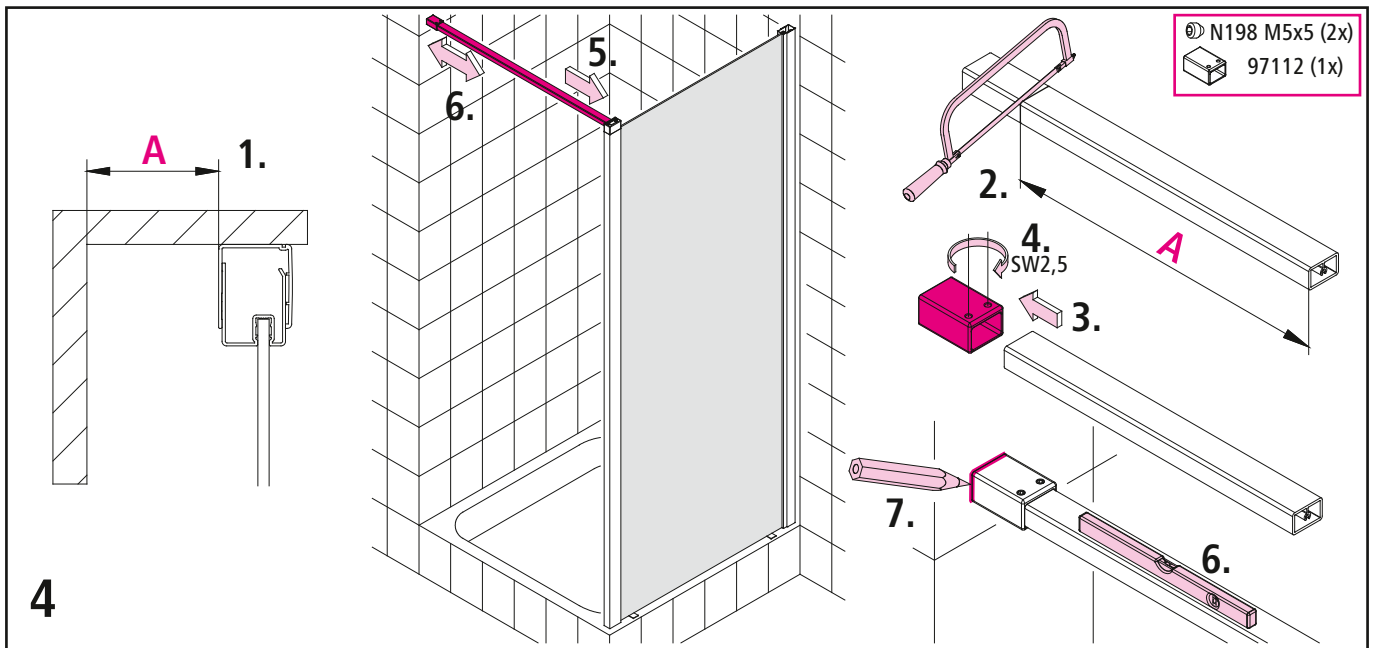
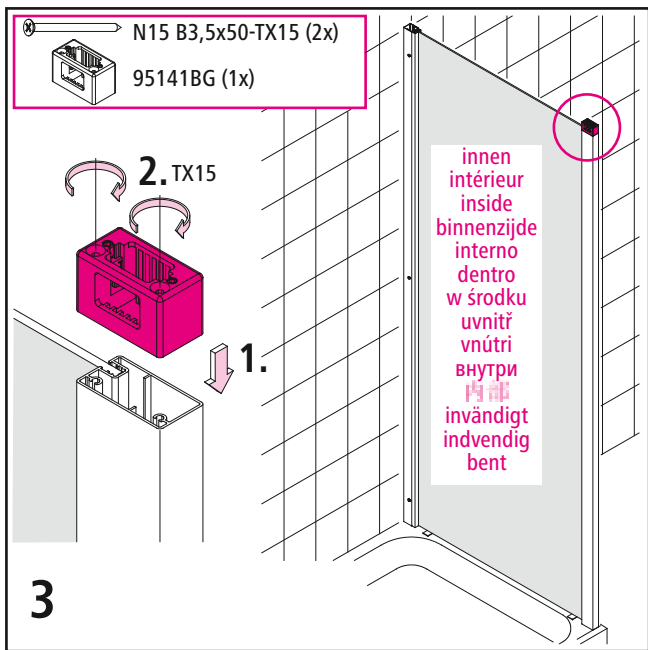

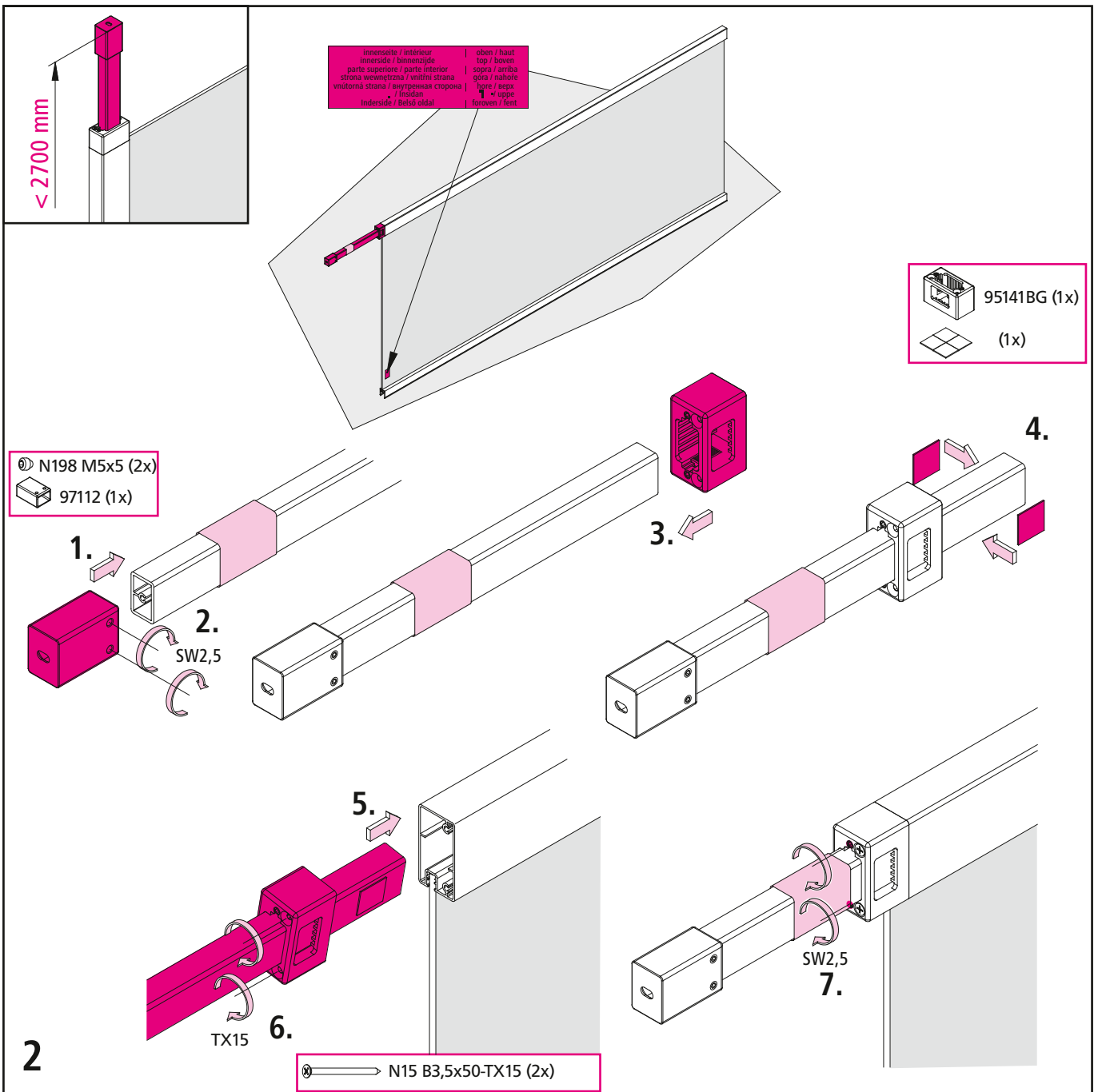
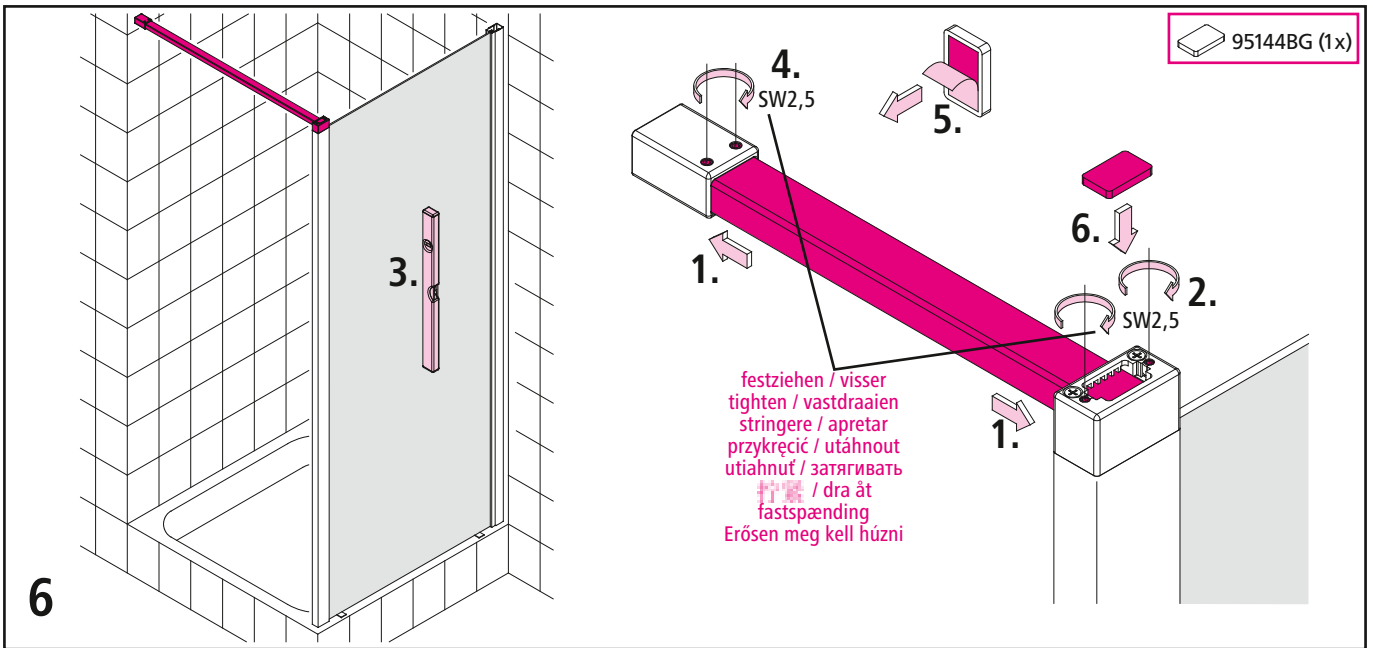

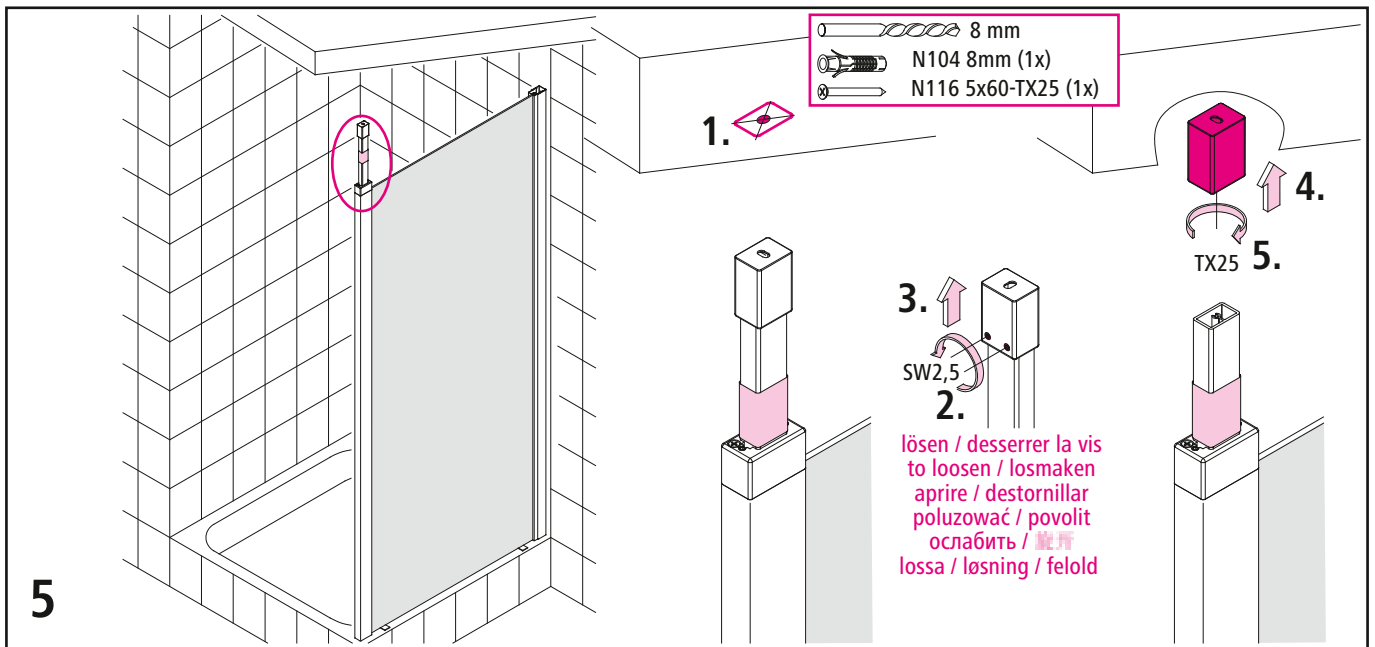
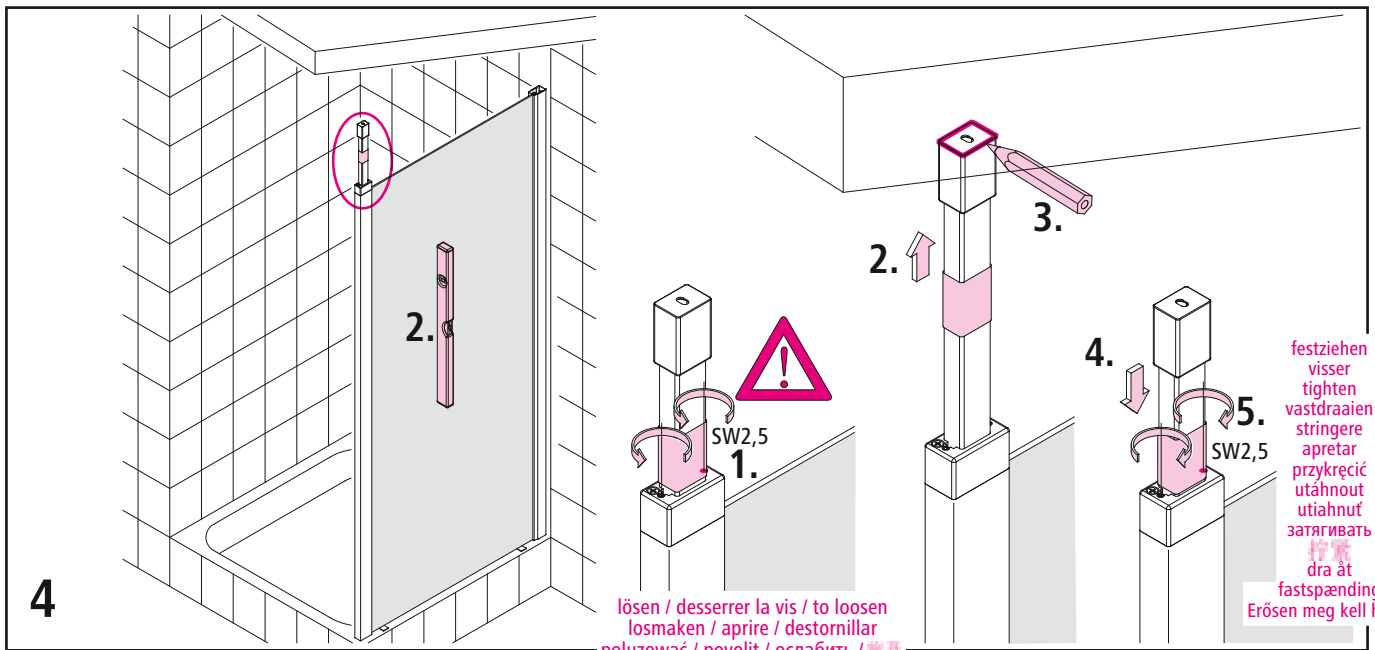
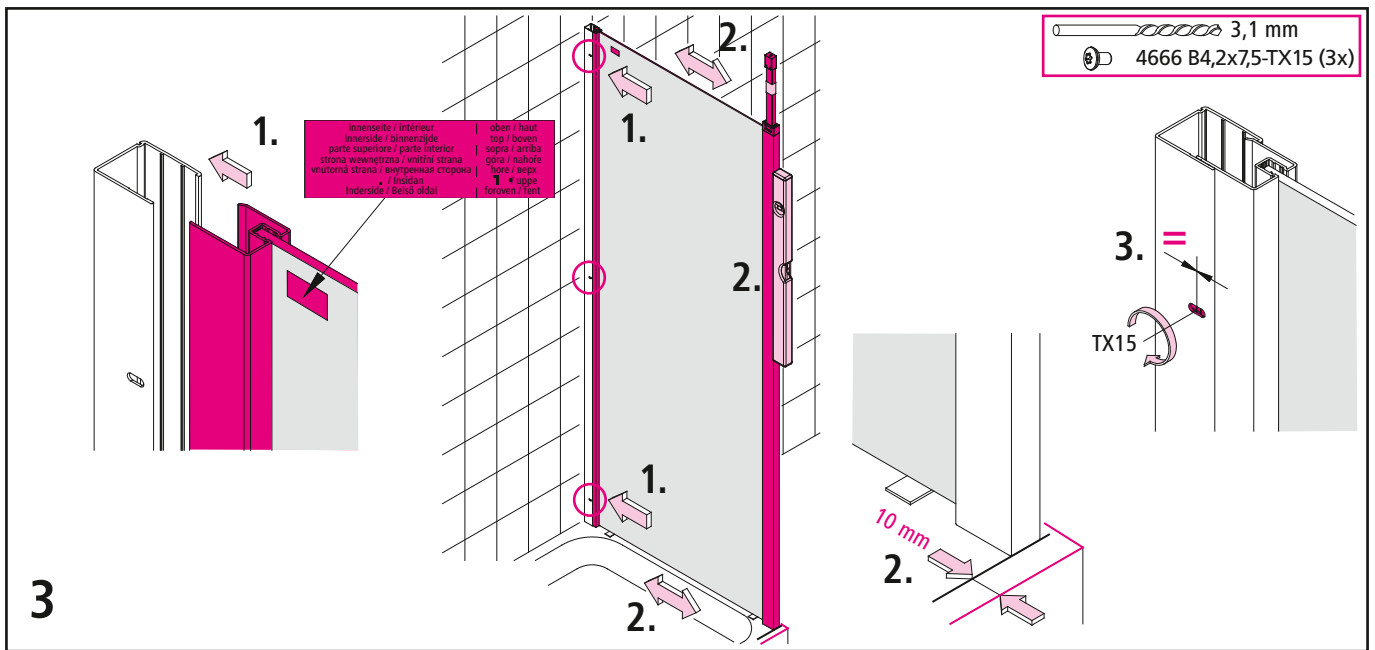



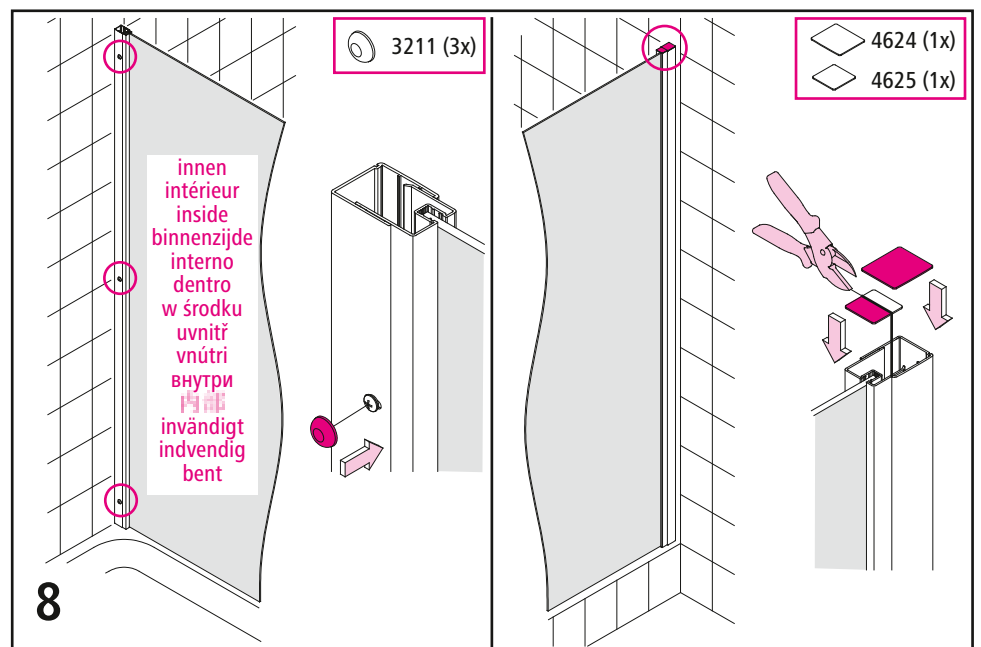
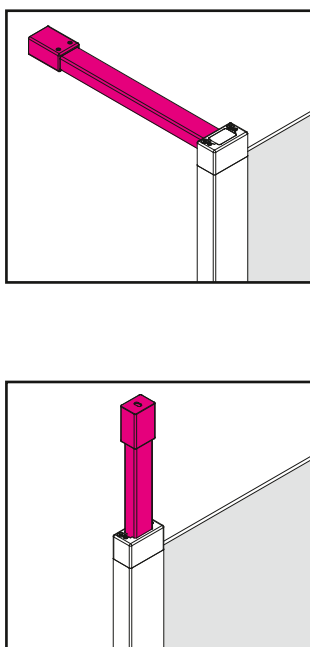
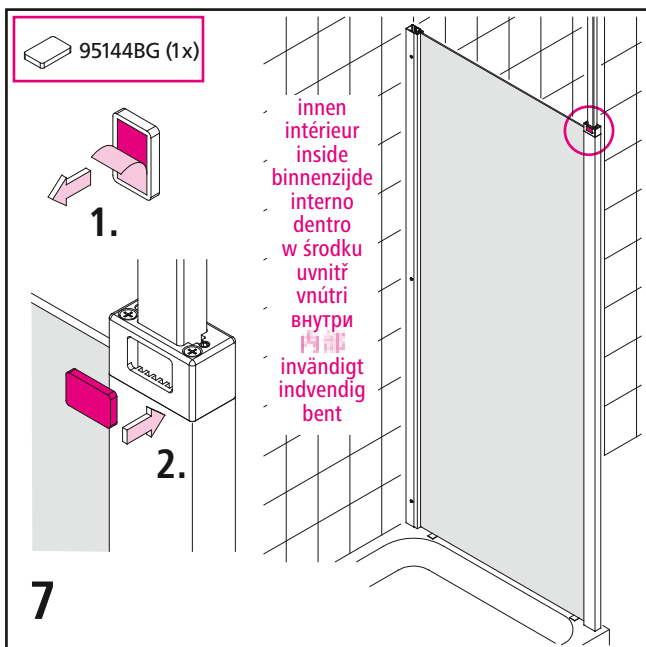
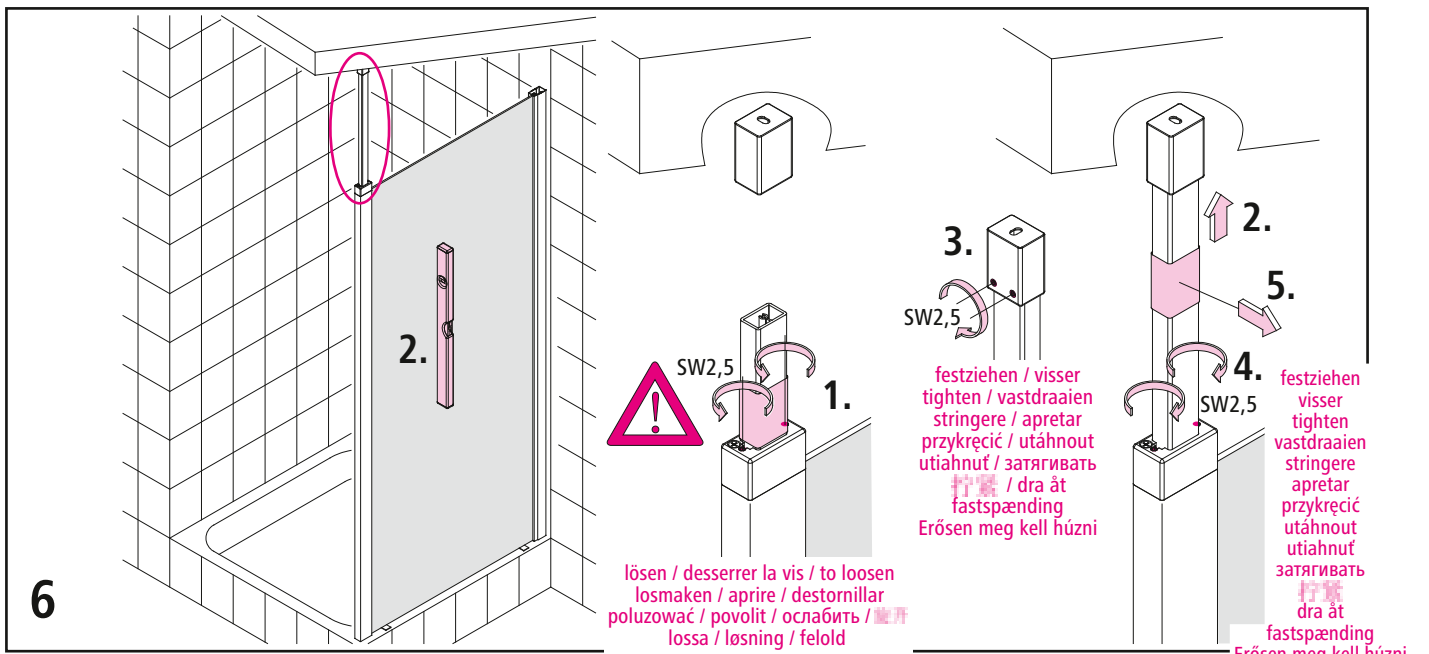

9

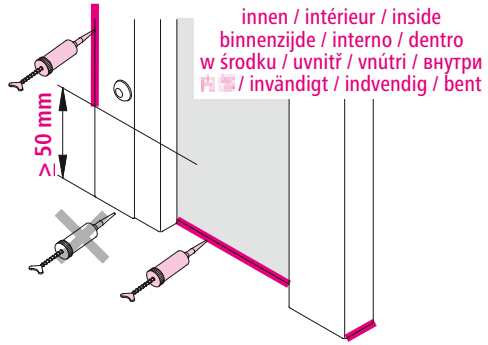
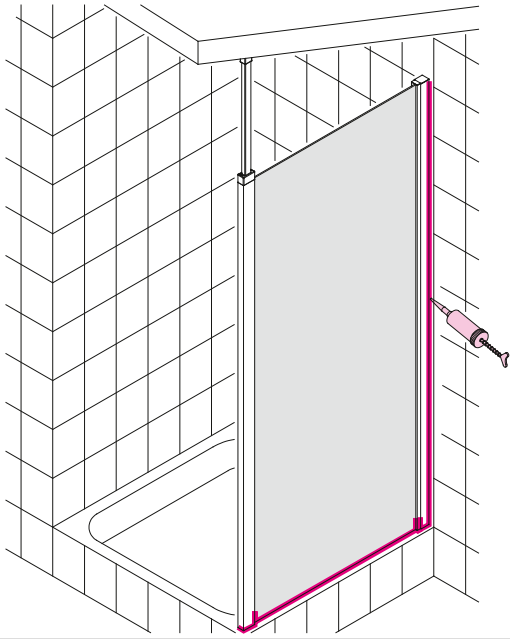

innen / intérieur / inside  
binnenzijde / interno / dentro  
w środku / uvnitř / vnitř / внутри  
西壁 / invändigt / indvendigt / bent

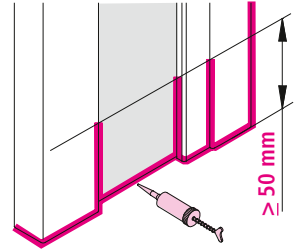
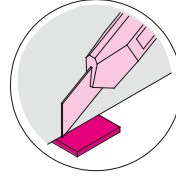

# WDW

