

L < 1,0 m - 3x  
 L > 1,0 m - 4x  
 L > 2,3 m - 5x

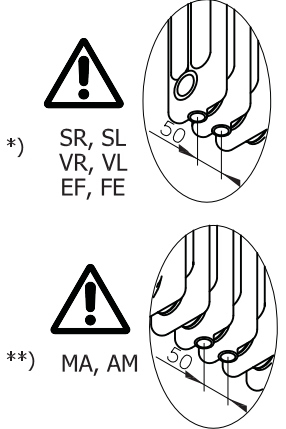

L < 1,0 m - 2x  
 L > 1,0 m - 3x  
 L > 2,3 m - 4x

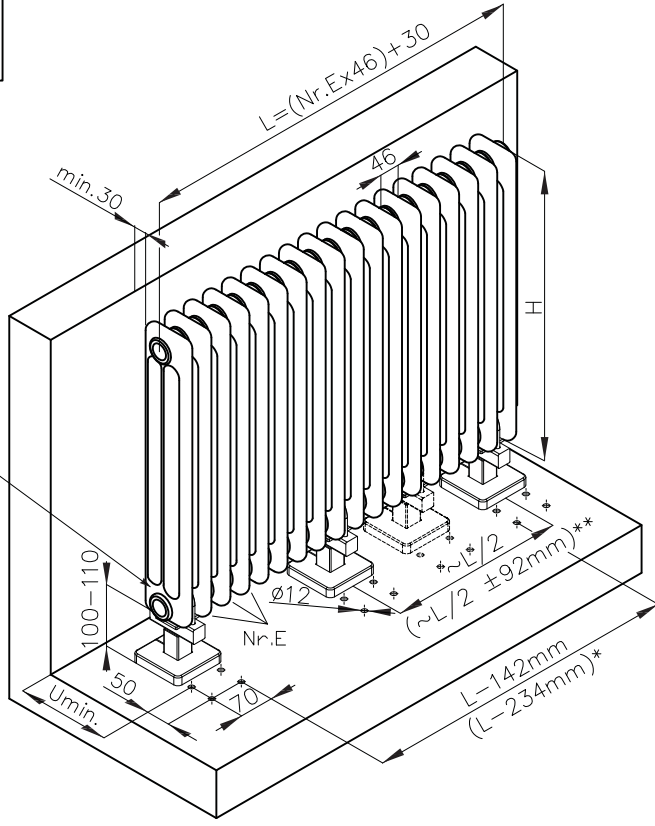
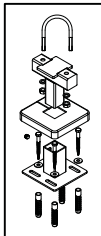

1x	1x	2x	2x	1x	1x	4x	4x	1x	4x

Atol	C2	C3	C4	C5	C6
Umin.[mm]	28	49	69	90	110



H ≤ 1000 mm

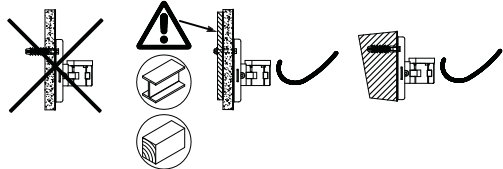

H > 1000 mm

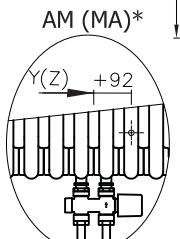
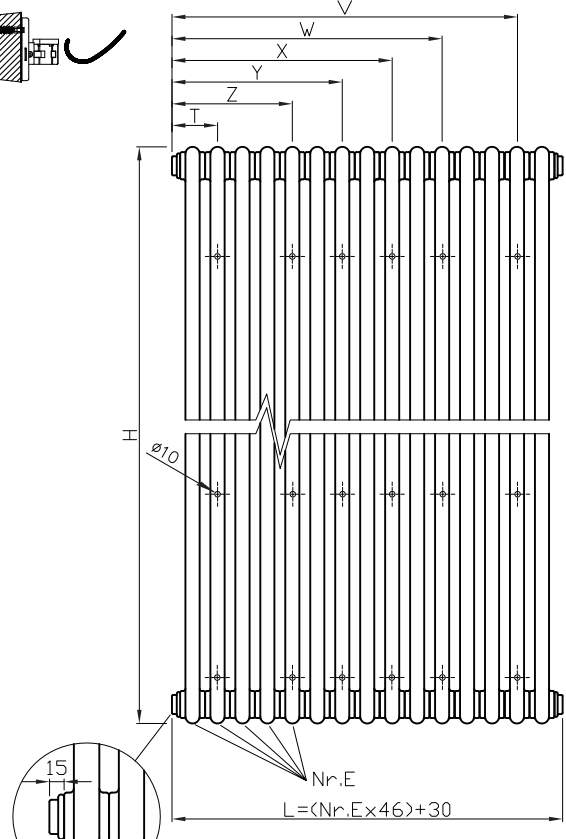
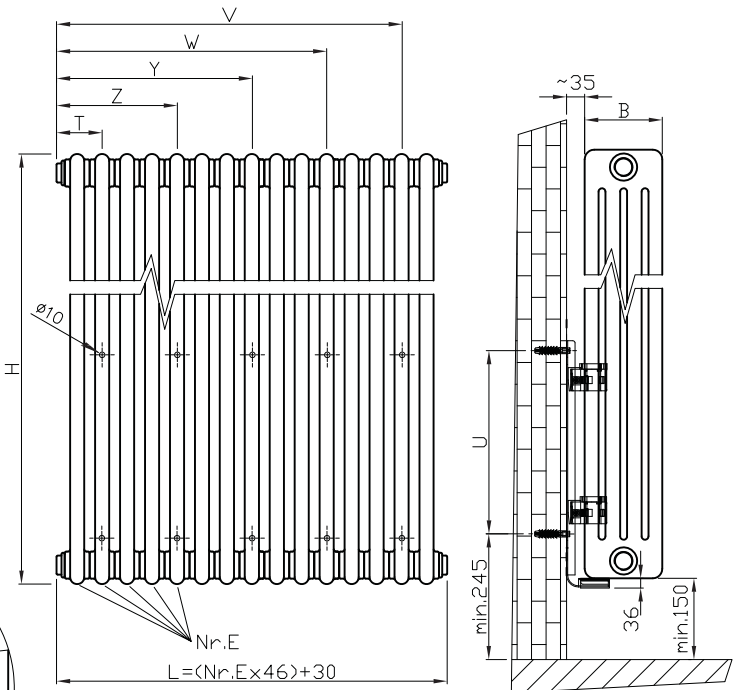

GTX

H [mm]	U [mm]
300 + 350	153
350 + 450	243
500 + 700	343
750 + 1000	593

Atol	C2	C3	C4	C5	C6
B [mm]	66	107	148	189	230

AB, CD, AD, CB, DA, BC, BD, DB, CA, AC, BB, DD, HG, GH, TL, TR + AM(MA)*						
Nr. E	T [mm]	V [mm]	Z [mm]	Y [mm]	X [mm]	W [mm]
4 + 9	38	L - 38	-	-	-	-
10 + 20	84	L - 84	-	-	-	-
21 + 35	84	L - 84	~ 1/2 L*	-	-	-
36 + 48	84	L - 84	~ 1/3 L	~ 2/3 L	-	-
49 + 60	84	L - 84	~ 1/4 L	~ 1/2 L*	~ 3/4 L	-

SR, VR						
Nr. E	T [mm]	V [mm]	Z [mm]	Y [mm]	X [mm]	W [mm]
4 + 9	38	L - 130	-	-	-	-
10 + 20	84	L - 130	-	-	-	-
21 + 35	84	L - 130	~ 1/2 L	-	-	-
36 + 48	84	L - 130	~ 1/3 L	~ 2/3 L	-	-
49 + 60	84	L - 130	~ 1/4 L	~ 1/2 L	~ 3/4 L	-

SL, VL						
Nr. E	T [mm]	V [mm]	Z [mm]	Y [mm]	X [mm]	W [mm]
4 + 9	130	L - 38	-	-	-	-
10 + 20	130	L - 84	-	-	-	-
21 + 35	130	L - 84	~ 1/2 L	-	-	-
36 + 48	130	L - 84	~ 1/3 L	~ 2/3 L	-	-
49 + 60	130	L - 84	~ 1/4 L	~ 1/2 L	~ 3/4 L	-

EF, FE						
Nr. E	T [mm]	V [mm]	Z [mm]	Y [mm]	X [mm]	W [mm]
4 + 9	84	L - 84	-	-	-	-
10 + 20	84	L - 84	-	-	-	-
21 + 35	84	L - 84	~ 1/2 L	-	-	-
36 + 48	84	L - 84	~ 1/3 L	~ 2/3 L	-	-
49 + 60	84	L - 84	~ 1/4 L	~ 1/2 L	~ 3/4 L	-

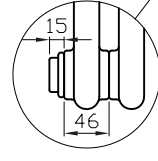
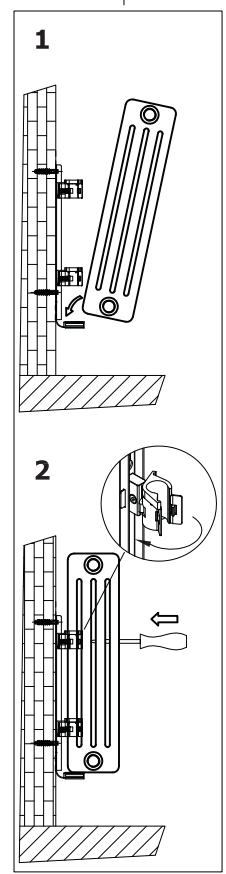

GTX + GTXP

Atol	C2	C3	C4	C5	C6
B [mm]	66	107	148	189	230

AB, CD, AD, CB, DA, BC, BD, DB, CA, AC, BB, DD, HG, GH, TL, TR, AM, MA						
Nr. E	T [mm]	V [mm]	Z [mm]	Y [mm]	X [mm]	W [mm]
4 + 9	38	L - 38	-	-	-	-
10 + 20	84	L - 84	~ 1/2 L	-	-	-
21 + 35	84	L - 84	~ 1/3 L	~ 2/3 L	-	-
36 + 48	84	L - 84	~ 1/4 L	~ 1/2 L	~ 3/4 L	-
49 + 60	84	L - 84	~ 1/5 L	~ 2/5 L	~ 3/5 L	~ 4/5 L

SR, VR						
Nr. E	T [mm]	V [mm]	Z [mm]	Y [mm]	X [mm]	W [mm]
4 + 9	38	L - 130	-	-	-	-
10 + 20	84	L - 130	~ 1/2 L	-	-	-
21 + 35	84	L - 130	~ 1/3 L	~ 2/3 L	-	-
36 + 48	84	L - 130	~ 1/4 L	~ 1/2 L	~ 3/4 L	-
49 + 60	84	L - 130	~ 1/5 L	~ 2/5 L	~ 3/5 L	~ 4/5 L

SL, VL						
Nr. E	T [mm]	V [mm]	Z [mm]	Y [mm]	X [mm]	W [mm]
4 + 9	130	L - 38	-	-	-	-
10 + 20	130	L - 84	~ 1/2 L	-	-	-
21 + 35	130	L - 84	~ 1/3 L	~ 2/3 L	-	-
36 + 48	130	L - 84	~ 1/4 L	~ 1/2 L	~ 3/4 L	-
49 + 60	130	L - 84	~ 1/5 L	~ 2/5 L	~ 3/5 L	~ 4/5 L

EF, FE						
Nr. E	T [mm]	V [mm]	Z [mm]	Y [mm]	X [mm]	W [mm]
4 + 9	84	L - 84	-	-	-	-
10 + 20	84	L - 84	~ 1/2 L	-	-	-
21 + 35	84	L - 84	~ 1/3 L	~ 2/3 L	-	-
36 + 48	84	L - 84	~ 1/4 L	~ 1/2 L	~ 3/4 L	-
49 + 60	84	L - 84	~ 1/5 L	~ 2/5 L	~ 3/5 L	~ 4/5 L